

RIGGING DIAGRAM - SINGLE MAIN LINE

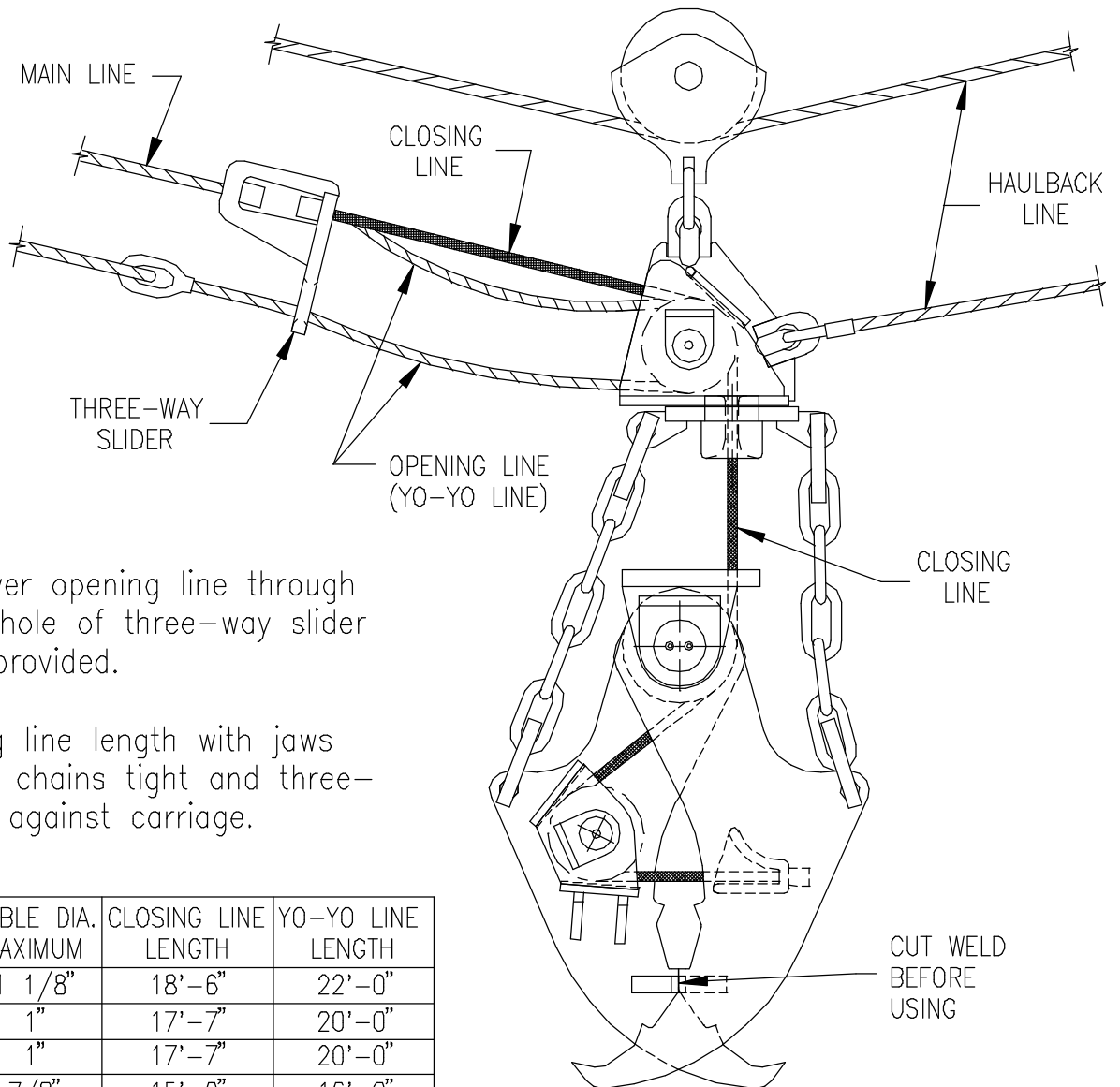

* Thread lower opening line through elongated hole of three-way slider if one is provided.

Set closing line length with jaws fully open, chains tight and three-way slider against carriage.

GRAPPLE MODEL	CABLE DIA. MAXIMUM	CLOSING LINE LENGTH	YO-YO LINE LENGTH
Y106HS	1 1/8"	18'-6"	22'-0"
Y96H	1"	17'-7"	20'-0"
Y96	1"	17'-7"	20'-0"
Y78	7/8"	15'-0"	16'-0"
Y56	3/4"	12'-6"	13'-6"

NOTES:

- Lubricate pins, bushings and sheaves every 4 hours of operation with good grade moly grease.
- There are 8 lubrication points.